

MASTER PART MARK	VIN	AVAILABLE THICKNESS	YIELD MIN.	BLANK LENGTH	BLANK WIDTH	WEIGHT (LBS)
MPBK03	A	26 GA	33 KSI	21.00	26.44	3.00

NO SCRATCHES ON OUTSIDE OF PART

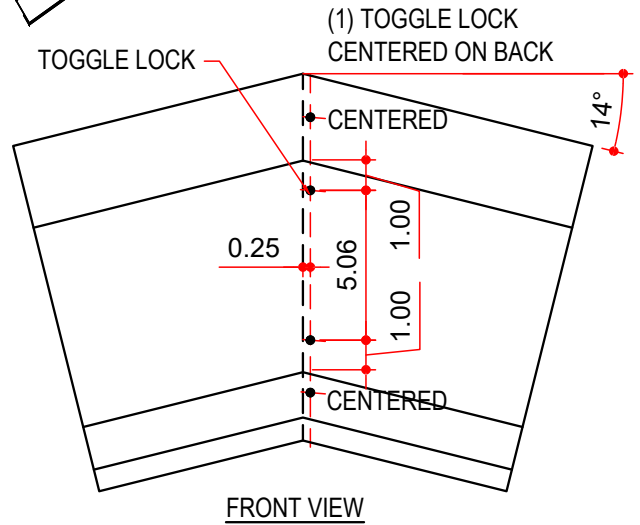
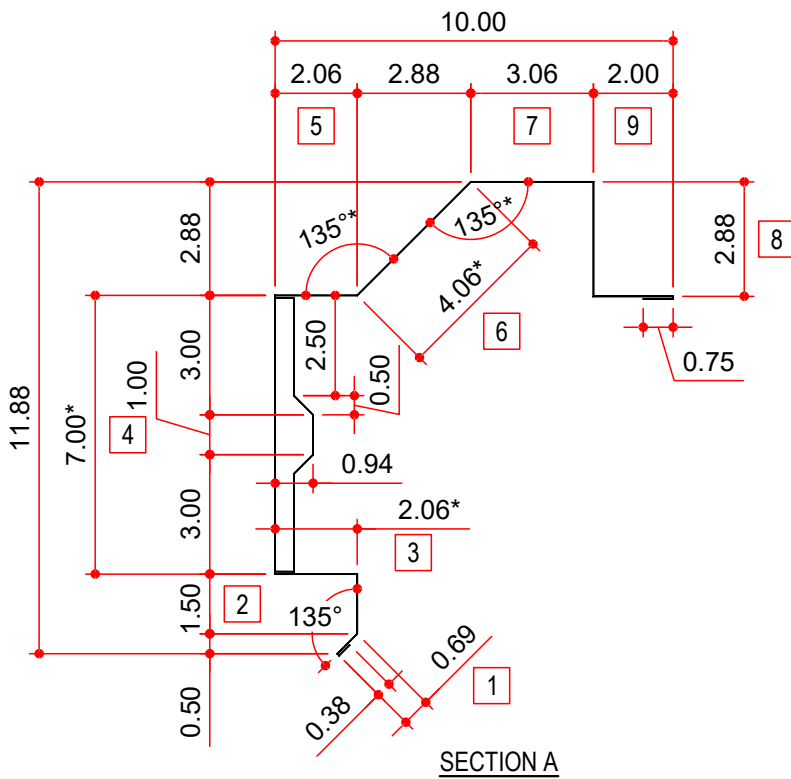
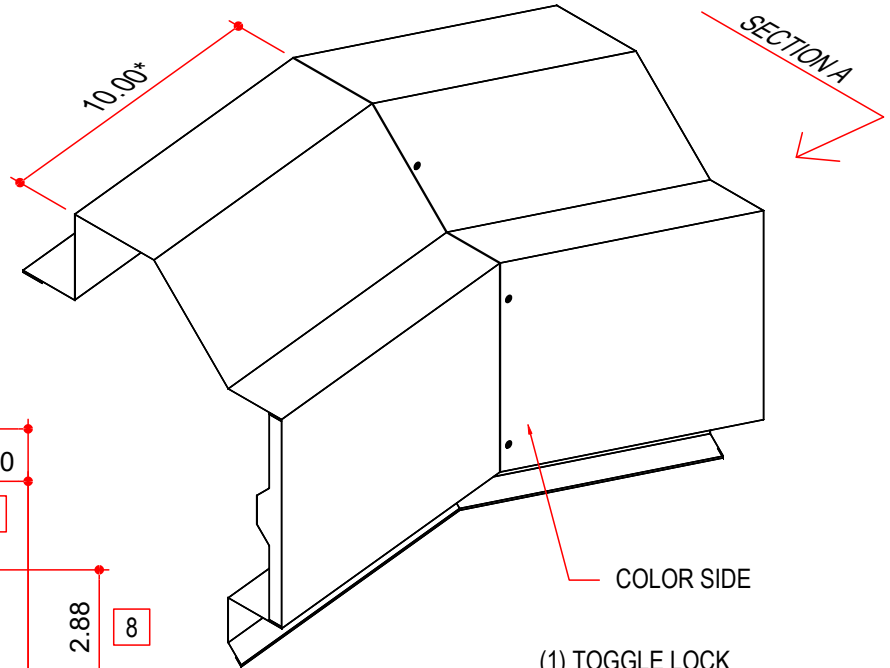

NOTES: BUYOUT

- 1) MPBK03 WORKS FOR SLOPES FROM 2 1/2:12 TO 3 1/2:12
- 2) ALL BENDS ARE 90° UNO
- 3) * INDICATES HOLD DIMENSION
- 4) ANGLE TOLERANCE ±2°
- 5) DIMENSIONAL TOLERANCE ±0.06
- 6) PART IS PRODUCED BY OUTSIDE SUPPLIER. DRAWING IS FOR REFERENCE ONLY

AVAILABLE COLORS

PW